

# OWNERS MANUAL

**10'6" x 32" x 6"**

***INDEX***  
***SLIPS***

## Construction

Double sidewall  
Reinforced outer sidewall  
EVA Deck Pad  
Airtight 3rd layer  
Basecloth  
Composite fiber layer  
Support baffles fiber drawing structure

## Features

Premium valve with quick-connect  
Anti exterior protective coating  
Military grade Duraweld PVC  
Thermosealed comfort non-slip deck pad  
Ultra reinforced composit dropstitch weave  
High pressure laminated structure



## **IMPORTANT**

### **READ THIS IMPORTANT INFORMATION BEFORE USING YOUR STAND-UP PADDLEBOARD**

**DISREGARDING ANY OF THE SAFETY PRECAUTIONS AND INSTRUCTIONS CONTAINED IN THE OWNER'S MANUAL AND/OR ON THE PRODUCT MAY RESULT IN INJURY, INCLUDING THE POSSIBILITY OF DEATH.**

- REVIEW THE WEIGHT CAPACITY LIMITATIONS OF THIS BOARD AND NEVER EXCEED IT.
- ALWAYS WEAR A COAST GUARD APPROVED PERSONAL FLOTATION DEVICE (PFD).
- NEVER GO PADDLEBOARDING IN SEVERE WEATHER OR WATER CONDITIONS THAT MIGHT AFFECT YOUR ABILITY TO STEER THE BOARD OR RETURN TO SHORE.
- NEVER ALLOW MINORS TO USE THIS BOARD WITHOUT ADULT SUPERVISION.
- NEVER CONSUME ALCOHOL OR ANY OTHER SUBSTANCES THAT MAY IMPAIR YOUR COORDINATION, JUDGEMENT, OR ABILITY TO SAFELY PADDLE THE BOARD.
- NEVER USE THIS BOARD BEYOND YOUR SKILLS OR ABILITY.
- NEVER USE THIS PRODUCT AFTER SUNSET, BEFORE DAWN OR AT ANY TIME IN POOR LIGHTING.
- CHECK LOCAL LAWS AND REGULATIONS REGARDING PROPER AND SAFE USE OF THIS PRODUCT.
- NEVER USE THE VALVE WRENCH TO DEFLATE AN INFLATED BOARD.
- PRESSURE GAUGE WILL ONLY REGISTER PRESSURE ABOVE 10 PSI.
- DO NOT INFLATE SUP ABOVE 15 PSI.
- KEEP CLEAR OF SHARP OBJECTS AND/OR HEAT PRODUCING OBJECTS.

## TABLE OF CONTENTS

# INFLATEX

### **SECTION 1**

PARTS & ACCESSORIES

### **SECTION 2**

CARE & MAINTENANCE

### **SECTION 3**

INFLATION &  
DEFLATION

### **SECTION 4**

FIN INSTALLATION

### **SECTION 5**

REPAIR

### **SECTION 6**

TRANSPORTATION TIPS

### **SECTION 7**

LIMITED LIFETIME  
WARRANTY

# SECTION 1

## PARTS & ACCESORIES

### PARTS & ACCESORIES

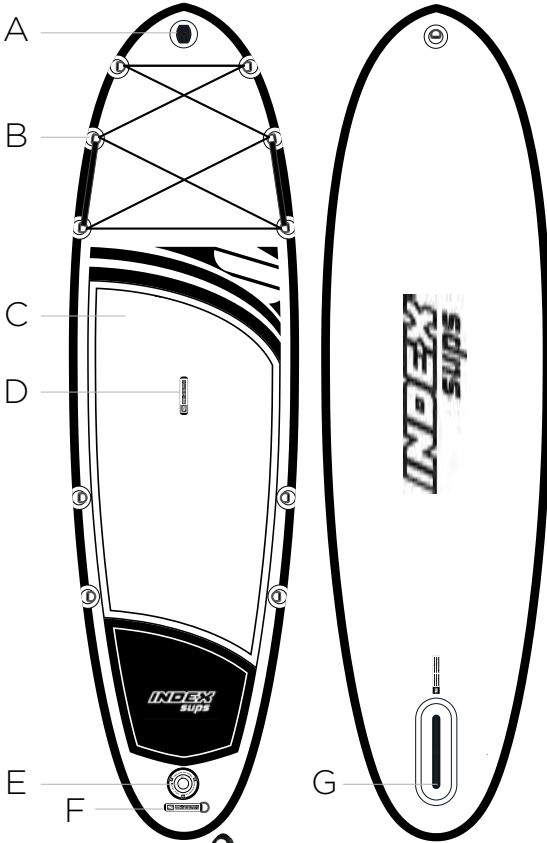

- A.** UTILITY MOUNT
- B.** BUNGEE RINGS & CORDS
- C.** DECK TRACTION PAD
- D.** CARRY HANDLE
- E.** AIR VALVE
- F.** LEASH D-RING
- G.** FIN CLAMP
- H.** HIGH PRESSURE PUMP
- I.** AIR HOSE
- J.** VALVE WRENCH
- K.** LEASH
- L.** BOARD TOTE
- M.** FIN
- N.** REPAIR KIT
- O.** PADDLE

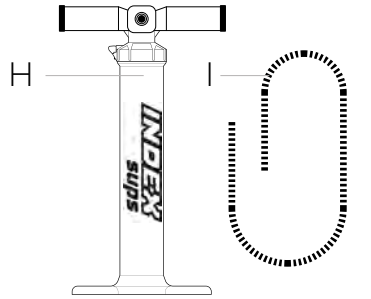

## SECTION 2

### CARE & MAINTENANCE



#### **KEEP IN A WELL VENTILATED, SHADED AREA WHEN NOT IN USE.**

Direct sunlight can damage a board if left exposed for a period of time. Heat can cause the air inside the board to expand beyond the internal pressure limits of the board. Keep your board in an area with good air flow and circulation. Leaving your board in a vehicle during the day (closed or open) elevates the risk for heat related damages.



#### **OPTIMAL INFLATION IS 12-15 PSI. DO NOT INFLATE BEYOND 18 PSI.**

Max pressure is 18 psi. Do not overinflate. If inflated in cooler early morning temperatures, inflate closer to the lower end of optimal inflation range. Inflating at a lower psi will allow for pressure expansion as the outside temperature warms during the course of the day.



#### **RINSE SAND AND SALTWATER DEPOSITS FROM YOUR BOARD AFTER USE.**

Sun, sand and saltwater will degrade any man-made material over time. Rinse off sand and saltwater deposits from your paddle board with fresh water and store in a cool, dry environment after each use.



#### **OVER-INFLATING YOUR PADDLE BOARD OR IMPROPER INFLATION/DEFLATION IS NOT COVERED UNDER WARRANTY!**

## SECTION 2

### CARE & MAINTENANCE



## CLOSE THE VENT BEFORE EACH USE OPEN THE VENT AFTER EACH USE.

Board bags are intended for transportation protection, not full time storage. Prolonged storage of a wet board in a wet board bag will have adverse effects on the finish of your board, leading to the possibility of mold, and osmotic blisters. Storing your board in a board bag is not the same as placing it in the shade. Board bags will collect heat and potentially overheat your board.



## HIGH PRESSURE PUMP

The DUAL-ACTION pump has a volume of capacity of 2000 cm<sup>3</sup> and can exert 2 BAR (29 PSI) of air pressure per pump. For added efficiency, engage the action selector to “DOUBLE ACTION” and exert an equal volume of air on both up and down strokes of the pump.

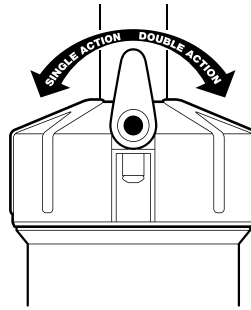
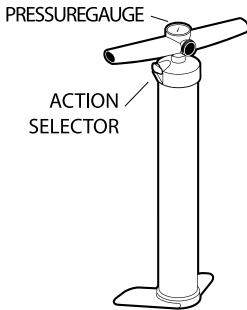

## REGULARLY MAINTAIN THE HIGH PRESSURE PUMP.

Unscrew the top of the pump and lubricate top edge and inside of tube.

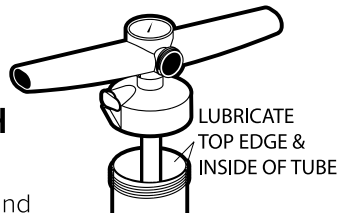

## SECTION 3

### INFLATION & DEFLATION

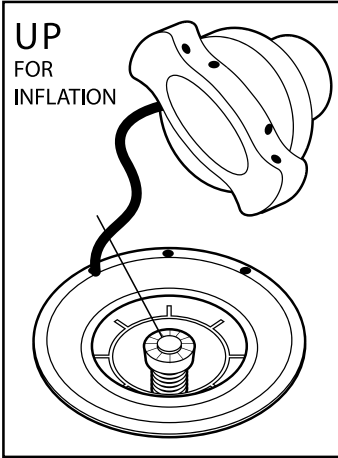

## SUP INFLATION

1. Fasten air hose to pressure gauge.
2. Locate the air valve on tail section of the board deck and open valve cap.
3. Turn the colored valve pin counter-clockwise to the "UP" position. The valve pin will prevent air from escaping when in the "UP" position.
4. Connect air hose to air valve and twist 90° to secure the connection.
5. Inflate to 12-15 psi.
6. Disconnect air hose from valve and close valve cap.

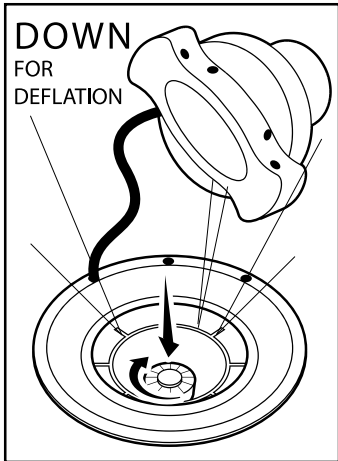

7. Open valve cap.
8. Depress colored valve pin and turn clockwise to lock the pin in the "DOWN" or open position.
9. Allow air to freely escape Inflatable SUP for a few minutes.
10. Beginning at the nose, tightly roll up Inflatable SUP to force remaining air through the air valve.

## SECTION 3

### INFLATION & DEFLATION

## TROUBLE SHOOTING LEAKING SUPS

### SUP NOT INFLATING/AIR ESCAPING SUP WHILE INFLATING

Verify the valve pin is in the “UP” position. “UP” keeps air in. “DOWN” allows air out.

Verify the air hose is securely fastened to the air valve.

The air valve may be loose. Refer to “VALVE TIGHTENING” below.

Check for tears and/or cracks. This is best performed in water. Submerge the sup and look for streams of air bubbles. If a large body of water is not available, try a spray bottle filled with water and dish soap. Spray the board along the seams and look for billowing soap bubbles. If a tear/hole is located, refer to “INFLATABLE SUP REPAIRS” in this manual.

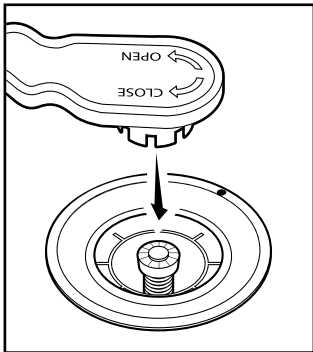
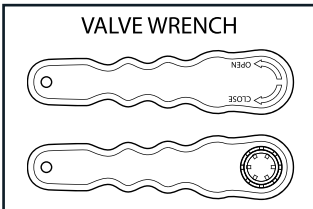

## VALVE TIGHTENING

Occasionally, the valve on your inflatable SUP may become loose. If the valve flange freely spins when opening the valve cover or you detect air leaking from the valve area, tightening may be required. Using the included valve wrench, tighten valve in a clockwise motion until hand tight.



**NEVER USE THE VALVE WRENCH WHEN SUP IS PRESSURIZED.**



## SECTION 4

### FIN INSTALLATION

#### FINS AND HARDWARE

**INDEX** INFLATABLE SUPS include a center stabilizer fin and a tool free screw set. We recommend removing fins after each use to prevent damage to the fin and board.

#### TOOL FREE SCREW SET



#### FIN

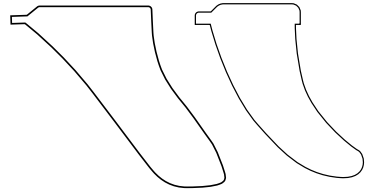

#### FIN INSTALLATION

1.

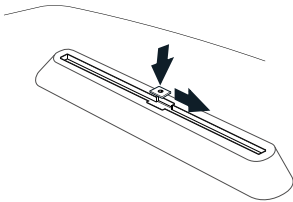

3.

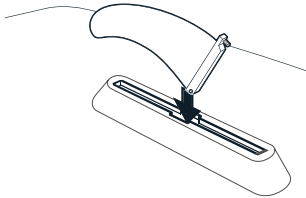

2.

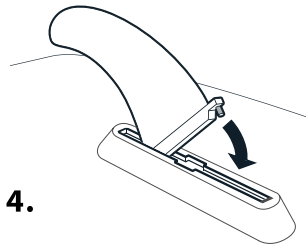

4.

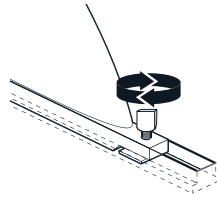

## SECTION 5

### REPAIR



**WEAR LATEX GLOVES TO AVOID SKIN IRRITATION.**

### BEFORE YOU START

Prepare the following items: Latex

Gloves (Pair) Isopropyl Alcohol

(Rubbing Alcohol) Clean Cloth Cement

Applicator (Brush, Popsicle® stick, etc.)

Emergency Repair Kit Contents

(Cement + Patches)

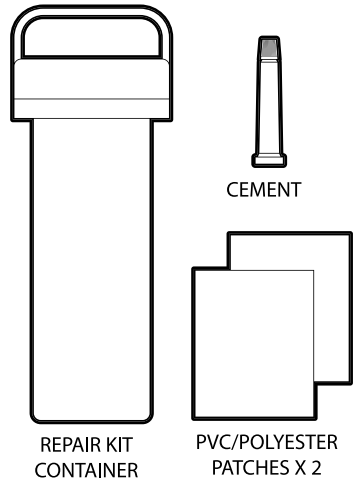

### BEFORE YOU START

1. Completely deflate paddle board.
2. Thoroughly clean the surface around the leak and the matte side of the PVC/ Polyester patch with rubbing alcohol. Both surfaces must be free of moisture, oil and debris.
3. Open the cement tube by breaking the tube seal using the outside of the tube cap.
4. Apply cement carefully and evenly to both paddle board surface and matte side patch surface. Avoid contact with skin & eyes. Avoid breathing cement vapors.
5. Allow cement on both board and patch to dry to the touch. Once dry, reapply a very thin layer of cement around the perimeter of the patch.
6. Once cement on both board and patch becomes tack-free, apply patch to board and firmly work out any trapped air bubbles.
7. Allow 8 hours for cement to cure before inflating paddleboard.

## SECTION 6

### TRANSPORTATION TIPS



### **DO NOT TRANSPORT AN INFLATED STAND UP PADDLE BOARD ON TOP OF A VEHICLE.**

Inflatable SUPs are designed to compact for convenient storage & travel. Due to a lack of weight when inflated, they will travel poorly if strapped to a vehicle rooftop. Damages incurred by improper transport are not covered by the manufacturer's warranty!

When transporting, be sure to clear any sharp objects. Punctures are not covered by the manufacturer's warranty!

Keep clear of any heat producing items such as camp stoves, propane lamps, etc. Damages resulting from heat are not covered by the manufacturer's warranty!

Allow your Inflatable SUP to completely dry before tightly rolling for packing. Excess moisture may cause mildew and/or mold damage



### **NEVER CARRY MORE THAN YOU CAN HANDLE COMFORTABLY.**

The included board tote is intended for Inflatable SUP and Inflatable SUP accessories only. Additional items added to the board tote may exceed weight capacity and result in damages to the tote, shoulder straps and/or carry handle.

When completely packed, an inflatable SUP and its accessories can get rather heavy. Make sure to never carry more than is comfortable for you in one trip. Always use proper lifting and carrying techniques to avoid straining muscles.

For maximum comfort when carrying the board tote, wear both shoulder straps to evenly distribute the carry weight. Tighten the shoulder straps to reduce slack and to avoid tote contents from resting on the back of the legs.

## SECTION 7 WARRANTY

### INDEX OFFERS A LIMITED 6 MONTH WARRANTY AGAINST DEFECTS ON MATERIALS AND WORKMANSHIP TERMS OF WARRANTY:

Your **INDEX** product is guaranteed to be free of defects in material and workmanship for a period of no more than **6 MONTH** from the date of purchase. If the product does not conform to the warranty, **INDEX**, at its discretion will issue a new, like new, or similar model product, excluding any shipping charges. Warranty extends to original purchaser only and is non-transferable. Sales receipt and original packaging materials are required.

#### WARRANTY:

**INDEX** will make every effort to produce boards to the highest quality and standards in the industry. We do quality checks in our factories and in our warehouses in North America in an effort to guarantee each board's quality before shipping. Because of the nature of surfing and paddle boarding we cannot warranty the performance of any board or shape for individual riders and varying levels of skills and abilities. Furthermore, we cannot guarantee against damage or breakage and cannot protect or warranty against circumstances outside of our control. In the event of a new board being removed from a box and not in good condition please contact the office for resolution. You will be asked for a copy of your sales receipt and photos of the damage in question, as well as original packaging material to verify if damage was due to shipping. If it is deemed a manufacturing or material flaw, we will issue an RMA number. This number along with the damaged product will need to be returned to the closest warehouse at customer's expense. Upon physical review, **INDEX** will make its final determination as to the nature of the damage or flaw and issue a replacement product (model depends on availability), or store credit. Shipping will be the responsibility of the customer. We are not responsible for damage or defects once the board has been used. Damage is defined as impact with any object or material, damage due to dropping, loading, unloading, or transport, alterations or modifications, repairs, natural disasters, fires, temperatures below 4.4 oC (40 oF), or above 43 oC (110 oF), any further use of a board once a claim has been reported, transport or storage of a board with a closed air valve, use of a board in the water with a loose or removed air valve, failure to clean and service air vent valve, storage of a board in extremely hot or humid conditions including a wet or damp board bag.

#### RETURNS AND EXCHANGES

**INDEX** will exchange any new, unused product for company credit providing it is accompanied by an original sales receipt and all original packaging. This will not include any shipping charges or expenses. Product must be in new condition and will be subject to the inspection of staff.

**INDEX**  
**SLIPS**

**[info@aldersportswear.com](mailto:info@aldersportswear.com)**